

# 3mA, 100MHz, 750V/ $\mu$ s Operational Amplifier with Shutdown

## FEATURES

- 100MHz Gain Bandwidth
- 750V/ $\mu$ s Slew Rate
- 3.6mA Maximum Supply Current
- Available in SOT-23 and S8 Packages
- 50 $\mu$ A Supply Current in Shutdown
- 8nV/ $\sqrt{\text{Hz}}$  Input Noise Voltage
- Unity-Gain Stable
- 1.5mV Maximum Input Offset Voltage
- 4 $\mu$ A Maximum Input Bias Current
- 400nA Maximum Input Offset Current
- 40mA Minimum Output Current,  $V_{OUT} = \pm 3V$
- $\pm 3.5V$  Minimum Input CMR,  $V_S = \pm 5V$
- 30ns Settling Time to 0.1%, 5V Step
- Specified at  $\pm 5V$ , Single 5V Supplies
- Operating Temperature Range:  $-40^{\circ}\text{C}$  to  $85^{\circ}\text{C}$

## APPLICATIONS

- Wideband Amplifiers
- Buffers
- Active Filters
- Video and RF Amplification
- Cable Drivers
- Data Acquisition Systems

## DESCRIPTION

The LT<sup>®</sup>1812 is a low power, high speed, very high slew rate operational amplifier with excellent DC performance. The LT1812 features reduced supply current, lower input offset voltage, lower input bias current and higher DC gain than other devices with comparable bandwidth. A power saving shutdown feature reduces supply current to 50 $\mu$ A. The circuit topology is a voltage feedback amplifier with the slewing characteristics of a current feedback amplifier.

The output drives a 100 $\Omega$  load to  $\pm 3.5V$  with  $\pm 5V$  supplies. On a single 5V supply, the output swings from 1.1V to 3.9V with a 100 $\Omega$  load connected to 2.5V. The amplifier is stable with a 1000pF capacitive load which makes it useful in buffer and cable driver applications.

The LT1812 is manufactured on Linear Technology's advanced low voltage complementary bipolar process. The dual version is the LT1813. For higher supply voltage single, dual and quad operational amplifiers with up to 70MHz gain bandwidth, see the LT1351 through LT1365 data sheets.

 LTC and LT are registered trademarks of Linear Technology Corporation.

## TYPICAL APPLICATION

4MHz, 4th Order Butterworth Filter

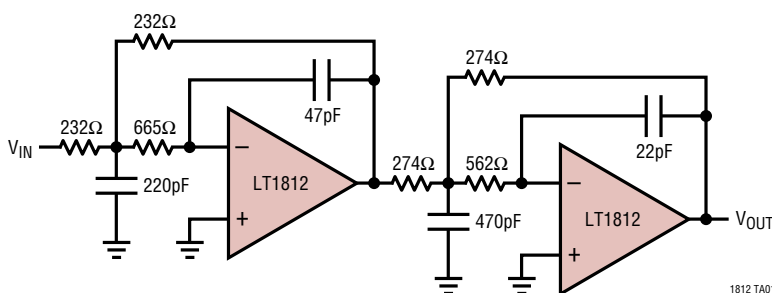

1812 TA01

Filter Frequency Response

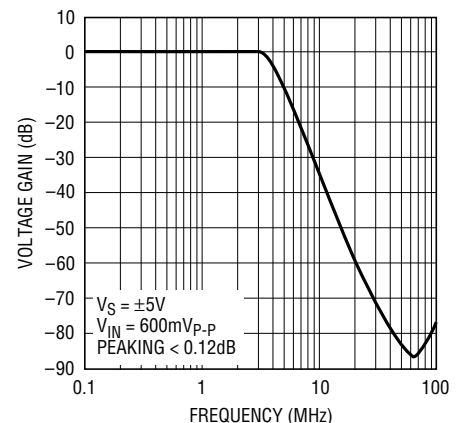

1812 TA02

## ABSOLUTE MAXIMUM RATINGS (Note 1)

Total Supply Voltage ( $V^+$ to $V^-$ ) .....	12.6V	Specified Temperature Range	
Differential Input Voltage (Transient Only, Note 2) ...	$\pm 3V$	(Note 8) .....	$-40^\circ C$ to $85^\circ C$
Input Voltage, Shutdown Voltage .....	$\pm V_S$	Maximum Junction Temperature .....	$150^\circ C$
Output Short-Circuit Duration (Note 3) .....	Indefinite	Storage Temperature Range .....	$-65^\circ C$ to $150^\circ C$
Operating Temperature Range (Note 8) ...	$-40^\circ C$ to $85^\circ C$	Lead Temperature (Soldering, 10 sec) .....	$300^\circ C$

## PACKAGE/ORDER INFORMATION

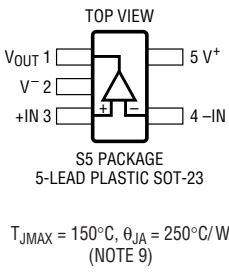
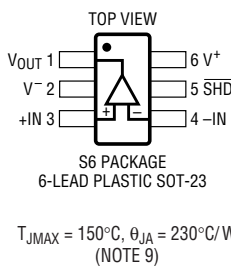
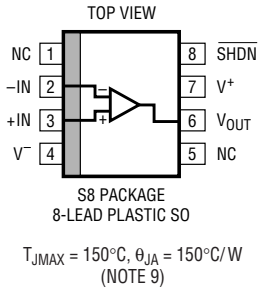
 <p>TOP VIEW</p> <p>S5 PACKAGE 5-LEAD PLASTIC SOT-23</p> <p><math>T_{JMAX} = 150^\circ C, \theta_{JA} = 250^\circ C/W</math> (NOTE 9)</p>	ORDER PART NUMBER	 <p>TOP VIEW</p> <p>S6 PACKAGE 6-LEAD PLASTIC SOT-23</p> <p><math>T_{JMAX} = 150^\circ C, \theta_{JA} = 230^\circ C/W</math> (NOTE 9)</p>	 <p>TOP VIEW</p> <p>S8 PACKAGE 8-LEAD PLASTIC SO</p> <p><math>T_{JMAX} = 150^\circ C, \theta_{JA} = 150^\circ C/W</math> (NOTE 9)</p>	ORDER PART NUMBER	
	LT1812CS5 LT1812IS5			LT1812CS6 LT1812IS6	LT1812CS8 LT1812IS8
	S5 PART MARKING			S6 PART MARKING	S8 PART MARKING
LTLH LTLJ	LTLK LTLJ	1812 1812I			

Consult factory for Military grade parts.

## ELECTRICAL CHARACTERISTICS $T_A = 25^\circ C, V_S = \pm 5V, V_{CM} = 0V$ unless otherwise noted (Note 10).

SYMBOL	PARAMETER	CONDITIONS	MIN	TYP	MAX	UNITS
$V_{OS}$	Input Offset Voltage	(Note 4)		0.4	1.5	mV
$I_{OS}$	Input Offset Current			30	400	nA
$I_B$	Input Bias Current			-0.9	$\pm 4$	$\mu A$
$e_n$	Input Noise Voltage Density	$f = 10kHz$		8		$nV/\sqrt{Hz}$
$i_n$	Input Noise Current Density	$f = 10kHz$		1		$pA/\sqrt{Hz}$
$R_{IN}$	Input Resistance	$V_{CM} = \pm 3.5V$ Differential	3	10 1.5		$M\Omega$ $M\Omega$
$C_{IN}$	Input Capacitance			2		pF
$V_{CM}$	Input Voltage Range (Positive) Input Voltage Range (Negative)		3.5	4.2 -4.2	-3.5	V V
CMRR	Common Mode Rejection Ratio	$V_{CM} = \pm 3.5V$	75	85		dB
	Minimum Supply Voltage			$\pm 1.25$	$\pm 2$	V
PSRR	Power Supply Rejection Ratio	$V_S = \pm 2V$ to $\pm 5.5V$	78	97		dB
$A_{VOL}$	Large-Signal Voltage Gain	$V_{OUT} = \pm 3V, R_L = 500\Omega$ $V_{OUT} = \pm 3V, R_L = 100\Omega$	1.5 1.0	3.0 2.5		V/mV V/mV
$V_{OUT}$	Maximum Output Swing	$R_L = 500\Omega, 30mV$ Overdrive $R_L = 100\Omega, 30mV$ Overdrive	$\pm 3.80$ $\pm 3.35$	$\pm 4.0$ $\pm 3.5$		V V
$I_{OUT}$	Maximum Output Current	$V_{OUT} = \pm 3V, 30mV$ Overdrive	$\pm 40$	$\pm 60$		mA
$I_{SC}$	Output Short-Circuit Current	$V_{OUT} = 0V, 1V$ Overdrive (Note 3)	$\pm 75$	$\pm 110$		mA
SR	Slew Rate	$A_V = -1$ (Note 5)	500	750		V/ $\mu s$

**ELECTRICAL CHARACTERISTICS**  $T_A = 25^\circ\text{C}$ ,  $V_S = \pm 5\text{V}$ ,  $V_{CM} = 0\text{V}$  unless otherwise noted (Note 10).

SYMBOL	PARAMETER	CONDITIONS	MIN	TYP	MAX	UNITS
FPBW	Full Power Bandwidth	3V Peak (Note 6)		40		MHz
GBW	Gain Bandwidth Product	$f = 200\text{kHz}$	75	100		MHz
$t_r, t_f$	Rise Time, Fall Time	$A_V = 1$ , 10% to 90%, 0.1V, $R_L = 100\Omega$		2		ns
OS	Overshoot	$A_V = 1$ , 0.1V, $R_L = 100\Omega$		25		%
$t_{PD}$	Propagation Delay	$A_V = 1$ , 50% $V_{IN}$ to 50% $V_{OUT}$ , 0.1V, $R_L = 100\Omega$		2.8		ns
$t_s$	Settling Time	5V Step, 0.1%, $A_V = -1$		30		ns
THD	Total Harmonic Distortion	$f = 1\text{MHz}$ , $V_{OUT} = 2V_{P-P}$ , $A_V = 2$ , $R_L = 500\Omega$		-76		dB
	Differential Gain	$V_{OUT} = 2V_{P-P}$ , $A_V = 2$ , $R_L = 150\Omega$		0.12		%
	Differential Phase	$V_{OUT} = 2V_{P-P}$ , $A_V = 2$ , $R_L = 150\Omega$		0.07		DEG
$R_{OUT}$	Output Resistance	$A_V = 1$ , $f = 1\text{MHz}$		0.4		$\Omega$
$I_{SHDN}$	SHDN Pin Current	$SHDN > V^- + 2.0\text{V}$ (On) (Note 11)		0	$\pm 1$	$\mu\text{A}$
		$SHDN < V^- + 0.4\text{V}$ (Off) (Note 11)	-100	-50		$\mu\text{A}$
$I_S$	Supply Current	$SHDN > V^- + 2.0\text{V}$ (On) (Note 11)		3	3.6	mA
		$SHDN < V^- + 0.4\text{V}$ (Off) (Note 11)		50	100	$\mu\text{A}$

$T_A = 25^\circ\text{C}$ ,  $V_S = 5\text{V}$ ,  $V_{CM} = 2.5\text{V}$ ,  $R_L$  to 2.5V unless otherwise noted (Note 10).

SYMBOL	PARAMETER	CONDITIONS	MIN	TYP	MAX	UNITS
$V_{OS}$	Input Offset Voltage	(Note 4)		0.5	2.0	mV
$I_{OS}$	Input Offset Current			30	400	nA
$I_B$	Input Bias Current			-1.0	$\pm 4$	$\mu\text{A}$
$e_n$	Input Noise Voltage Density	$f = 10\text{kHz}$		8		$\text{nV}/\sqrt{\text{Hz}}$
$i_n$	Input Noise Current Density	$f = 10\text{kHz}$		1		$\text{pA}/\sqrt{\text{Hz}}$
$R_{IN}$	Input Resistance	$V_{CM} = 1.5\text{V}$ to 3.5V Differential	3	10		$\text{M}\Omega$
				1.5		$\text{M}\Omega$
$C_{IN}$	Input Capacitance			2		pF
$V_{CM}$	Input Voltage Range (Positive) Input Voltage Range (Negative)		3.5	4		V
				1	1.5	V
CMRR	Common Mode Rejection Ratio	$V_{CM} = 1.5\text{V}$ to 3.5V	73	82		dB
$A_{VOL}$	Large-Signal Voltage Gain	$V_{OUT} = 1.5\text{V}$ to 3.5V, $R_L = 500\Omega$	1.0	2.0		V/mV
		$V_{OUT} = 1.5\text{V}$ to 3.5V, $R_L = 100\Omega$	0.7	1.5		V/mV
$V_{OUT}$	Maximum Output Swing (Positive)	$R_L = 500\Omega$ , 30mV Overdrive	3.9	4.1		V
		$R_L = 100\Omega$ , 30mV Overdrive	3.7	3.9		V
	Maximum Output Swing (Negative)	$R_L = 500\Omega$ , 30mV Overdrive		0.9	1.1	V
		$R_L = 100\Omega$ , 30mV Overdrive		1.1	1.3	V
$I_{OUT}$	Maximum Output Current	$V_{OUT} = 3.5\text{V}$ or 1.5V, 30mV Overdrive	$\pm 25$	$\pm 40$		mA
$I_{SC}$	Output Short-Circuit Current	$V_{OUT} = 2.5\text{V}$ , 1V Overdrive (Note 3)	$\pm 55$	$\pm 80$		mA
SR	Slew Rate	$A_V = -1$ (Note 5)	200	350		V/ $\mu\text{s}$
FPBW	Full Power Bandwidth	1V Peak (Note 6)		55		MHz
GBW	Gain Bandwidth Product	$f = 200\text{kHz}$	65	94		MHz
$t_r, t_f$	Rise Time, Fall Time	$A_V = 1$ , 10% to 90%, 0.1V, $R_L = 100\Omega$		2.1		ns
OS	Overshoot	$A_V = 1$ , 0.1V, $R_L = 100\Omega$		25		%
$t_{PD}$	Propagation Delay	$A_V = 1$ , 50% $V_{IN}$ to 50% $V_{OUT}$ , 0.1V, $R_L = 100\Omega$		3		ns
$t_s$	Settling Time	2V Step, 0.1%, $A_V = -1$		30		ns
THD	Total Harmonic Distortion	$f = 1\text{MHz}$ , $V_{OUT} = 2V_{P-P}$ , $A_V = 2$ , $R_L = 500\Omega$		-75		dB
	Differential Gain	$V_{OUT} = 2V_{P-P}$ , $A_V = 2$ , $R_L = 150\Omega$		0.22		%
	Differential Phase	$V_{OUT} = 2V_{P-P}$ , $A_V = 2$ , $R_L = 150\Omega$		0.21		DEG

**ELECTRICAL CHARACTERISTICS**  $T_A = 25^\circ\text{C}$ ,  $V_S = 5\text{V}$ ,  $V_{CM} = 2.5\text{V}$ ,  $R_L$  to 2.5V unless otherwise noted (Note 10).

SYMBOL	PARAMETER	CONDITIONS	MIN	TYP	MAX	UNITS
$R_{OUT}$	Output Resistance	$A_V = 1$ , $f = 1\text{MHz}$		0.45		$\Omega$
$I_{SHDN}$	SHDN Pin Current	$\overline{SHDN} > V^- + 2.0\text{V}$ (On) (Note 11) $\overline{SHDN} < V^- + 0.4\text{V}$ (Off) (Note 11)	-50	0 -20	$\pm 1$	$\mu\text{A}$ $\mu\text{A}$
$I_S$	Supply Current	$\overline{SHDN} > V^- + 2.0\text{V}$ (On) (Note 11) $\overline{SHDN} < V^- + 0.4\text{V}$ (Off) (Note 11)		2.7 20	3.6 50	$\text{mA}$ $\mu\text{A}$

$0^\circ\text{C} \leq T_A \leq 70^\circ\text{C}$ ,  $V_S = \pm 5\text{V}$ ,  $V_{CM} = 0\text{V}$  unless otherwise noted (Note 10).

SYMBOL	PARAMETER	CONDITIONS	MIN	TYP	MAX	UNITS
$V_{OS}$	Input Offset Voltage	(Note 4)			2	mV
$\Delta V_{OS}/\Delta T$	Input Offset Voltage Drift	(Note 7)		10	15	$\mu\text{V}/^\circ\text{C}$
$I_{OS}$	Input Offset Current				500	nA
$I_B$	Input Bias Current				$\pm 5$	$\mu\text{A}$
$V_{CM}$	Input Voltage Range (Positive) Input Voltage Range (Negative)		3.5		-3.5	V V
CMRR	Common Mode Rejection Ratio	$V_{CM} = \pm 3.5\text{V}$	73			dB
	Minimum Supply Voltage				$\pm 2$	V
PSRR	Power Supply Rejection Ratio	$V_S = \pm 2\text{V}$ to $\pm 5.5\text{V}$	76			dB
$A_{VOL}$	Large-Signal Voltage Gain	$V_{OUT} = \pm 3\text{V}$ , $R_L = 500\Omega$ $V_{OUT} = \pm 3\text{V}$ , $R_L = 100\Omega$	1.0 0.7			V/mV V/mV
$V_{OUT}$	Maximum Output Swing	$R_L = 500\Omega$ , 30mV Overdrive $R_L = 100\Omega$ , 30mV Overdrive	$\pm 3.70$ $\pm 3.25$			V V
$I_{OUT}$	Maximum Output Current	$V_{OUT} = \pm 3\text{V}$ , 30mV Overdrive	$\pm 35$			mA
$I_{SC}$	Output Short-Circuit Current	$V_{OUT} = 0\text{V}$ , 1V Overdrive (Note 3)	$\pm 60$			mA
SR	Slew Rate	$A_V = -1$ (Note 5)	400			V/ $\mu\text{s}$
GBW	Gain Bandwidth Product	$f = 200\text{kHz}$	65			MHz
$I_{SHDN}$	SHDN Pin Current	$\overline{SHDN} > V^- + 2.0\text{V}$ (On) (Note 11) $\overline{SHDN} < V^- + 0.4\text{V}$ (Off) (Note 11)	-150		$\pm 1.5$	$\mu\text{A}$ $\mu\text{A}$
$I_S$	Supply Current	$\overline{SHDN} > V^- + 2.0\text{V}$ (On) (Note 11) $\overline{SHDN} < V^- + 0.4\text{V}$ (Off) (Note 11)			4.6 150	$\text{mA}$ $\mu\text{A}$

## ELECTRICAL CHARACTERISTICS

$0^{\circ}\text{C} \leq T_A \leq 70^{\circ}\text{C}$ ,  $V_S = 5\text{V}$ ,  $V_{CM} = 2.5\text{V}$ ,  $R_L$  to  $2.5\text{V}$  unless otherwise noted (Note 10).

SYMBOL	PARAMETER	CONDITIONS	MIN	TYP	MAX	UNITS
$V_{OS}$	Input Offset Voltage	(Note 4)			2.5	mV
$\Delta V_{OS}/\Delta T$	Input Offset Voltage Drift	(Note 7)		10	15	$\mu\text{V}/^{\circ}\text{C}$
$I_{OS}$	Input Offset Current				500	nA
$I_B$	Input Bias Current				$\pm 5$	$\mu\text{A}$
$V_{CM}$	Input Voltage Range (Positive) Input Voltage Range (Negative)		3.5		1.5	V V
CMRR	Common Mode Rejection Ratio	$V_{CM} = 1.5\text{V}$ to $3.5\text{V}$	71			dB
$A_{VOL}$	Large-Signal Voltage Gain	$V_{OUT} = 1.5\text{V}$ to $3.5\text{V}$ , $R_L = 500\Omega$ $V_{OUT} = 1.5\text{V}$ to $3.5\text{V}$ , $R_L = 100\Omega$	0.7 0.5			V/mV V/mV
$V_{OUT}$	Maximum Output Swing (Positive)	$R_L = 500\Omega$ , 30mV Overdrive $R_L = 100\Omega$ , 30mV Overdrive	3.8 3.6			V V
	Maximum Output Swing (Negative)	$R_L = 500\Omega$ , 30mV Overdrive $R_L = 100\Omega$ , 30mV Overdrive			1.2 1.4	V V
$I_{OUT}$	Maximum Output Current	$V_{OUT} = 3.5\text{V}$ or $1.5\text{V}$ , 30mV Overdrive	$\pm 20$			mA
$I_{SC}$	Output Short-Circuit Current	$V_{OUT} = 2.5\text{V}$ , 1V Overdrive (Note 3)	$\pm 45$			mA
SR	Slew Rate	$A_V = -1$ (Note 5)	150			V/ $\mu\text{s}$
GBW	Gain Bandwidth Product	$f = 200\text{kHz}$	55			MHz
$I_{SHDN}$	SHDN Pin Current	$\overline{\text{SHDN}} > V^- + 2.0\text{V}$ (On) (Note 11) $\overline{\text{SHDN}} < V^- + 0.4\text{V}$ (Off) (Note 11)	-75		$\pm 1.5$	$\mu\text{A}$ $\mu\text{A}$
$I_S$	Supply Current	$\overline{\text{SHDN}} > V^- + 2.0\text{V}$ (On) (Note 11)			4.5	mA
		$\overline{\text{SHDN}} < V^- + 0.4\text{V}$ (Off) (Note 11)			75	$\mu\text{A}$

$-40^{\circ}\text{C} \leq T_A \leq 85^{\circ}\text{C}$ ,  $V_S = \pm 5\text{V}$ ,  $V_{CM} = 0\text{V}$  unless otherwise noted (Notes 8, 10).

SYMBOL	PARAMETER	CONDITIONS	MIN	TYP	MAX	UNITS
$V_{OS}$	Input Offset Voltage	(Note 4)			3	mV
$\Delta V_{OS}/\Delta T$	Input Offset Voltage Drift	(Note 7)		10	30	$\mu\text{V}/^{\circ}\text{C}$
$I_{OS}$	Input Offset Current				600	nA
$I_B$	Input Bias Current				$\pm 6$	$\mu\text{A}$
$V_{CM}$	Input Voltage Range (Positive) Input Voltage Range (Negative)		3.5		-3.5	V V
CMRR	Common Mode Rejection Ratio	$V_{CM} = \pm 3.5\text{V}$	72			dB
	Minimum Supply Voltage				$\pm 2$	V
PSRR	Power Supply Rejection Ratio	$V_S = \pm 2\text{V}$ to $\pm 5.5\text{V}$	75			dB
$A_{VOL}$	Large-Signal Voltage Gain	$V_{OUT} = \pm 3\text{V}$ , $R_L = 500\Omega$	0.8			V/mV
		$V_{OUT} = \pm 3\text{V}$ , $R_L = 100\Omega$	0.6			V/mV
$V_{OUT}$	Maximum Output Swing	$R_L = 500\Omega$ , 30mV Overdrive	$\pm 3.60$			V
		$R_L = 100\Omega$ , 30mV Overdrive	$\pm 3.15$			V
$I_{OUT}$	Maximum Output Current	$V_{OUT} = \pm 3\text{V}$ , 30mV Overdrive	$\pm 30$			mA
$I_{SC}$	Output Short-Circuit Current	$V_{OUT} = 0\text{V}$ , 1V Overdrive (Note 3)	$\pm 55$			mA
SR	Slew Rate	$A_V = -1$ (Note 5)	350			V/ $\mu\text{s}$
GBW	Gain Bandwidth Product	$f = 200\text{kHz}$	60			MHz
$I_{SHDN}$	SHDN Pin Current	$\overline{\text{SHDN}} > V^- + 2.0\text{V}$ (On) (Note 11) $\overline{\text{SHDN}} < V^- + 0.4\text{V}$ (Off) (Note 11)	-200		$\pm 2$	$\mu\text{A}$ $\mu\text{A}$
$I_S$	Supply Current	$\overline{\text{SHDN}} > V^- + 2.0\text{V}$ (On) (Note 11)			5	mA
		$\overline{\text{SHDN}} < V^- + 0.4\text{V}$ (Off) (Note 11)			200	$\mu\text{A}$

## ELECTRICAL CHARACTERISTICS

–40°C ≤ T<sub>A</sub> ≤ 85°C, V<sub>S</sub> = 5V, V<sub>CM</sub> = 2.5V, R<sub>L</sub> to 2.5V unless otherwise noted (Notes 8, 10).

SYMBOL	PARAMETER	CONDITIONS	MIN	TYP	MAX	UNITS
V <sub>OS</sub>	Input Offset Voltage	(Note 4)			3.5	mV
ΔV <sub>OS</sub> /ΔT	Input Offset Voltage Drift	(Note 7)		10	30	μV/°C
I <sub>OS</sub>	Input Offset Current				600	nA
I <sub>B</sub>	Input Bias Current				±6	μA
V <sub>CM</sub>	Input Voltage Range (Positive) Input Voltage Range (Negative)		3.5		1.5	V V
CMRR	Common Mode Rejection Ratio	V <sub>CM</sub> = 1.5V to 3.5V	70			dB
A <sub>VOL</sub>	Large-Signal Voltage Gain	V <sub>OUT</sub> = 1.5V to 3.5V, R <sub>L</sub> = 500Ω V <sub>OUT</sub> = 2.0V to 3.0V, R <sub>L</sub> = 100Ω	0.6 0.4			V/mV V/mV
V <sub>OUT</sub>	Maximum Output Swing (Positive)	R <sub>L</sub> = 500Ω, 30mV Overdrive R <sub>L</sub> = 100Ω, 30mV Overdrive	3.7 3.5			V V
	Maximum Output Swing (Negative)	R <sub>L</sub> = 500Ω, 30mV Overdrive R <sub>L</sub> = 100Ω, 30mV Overdrive			1.3 1.5	V V
I <sub>OUT</sub>	Maximum Output Current	V <sub>OUT</sub> = 3.5V or 1.5V, 30mV Overdrive	±17			mA
I <sub>SC</sub>	Output Short-Circuit Current	V <sub>OUT</sub> = 2.5V, 1V Overdrive (Note 3)	±40			mA
SR	Slew Rate	A <sub>V</sub> = –1 (Note 5)	125			V/μs
GBW	Gain Bandwidth Product	f = 200kHz	50			MHz
I <sub>SHDN</sub>	SHDN Pin Current	SHDN > V <sup>-</sup> + 2.0V (On) (Note 11) SHDN < V <sup>-</sup> + 0.4V (Off) (Note 11)	–100		±2	μA μA
I <sub>S</sub>	Supply Current	SHDN > V <sup>-</sup> + 2.0V (On) (Note 11) SHDN < V <sup>-</sup> + 0.4V (Off) (Note 11)			5 100	mA μA

**Note 1:** Absolute Maximum Ratings are those values beyond which the life of the device may be impaired.

**Note 2:** Differential inputs of ±3V are appropriate for transient operation only, such as during slewing. Large sustained differential inputs can cause excessive power dissipation and may damage the part.

**Note 3:** A heat sink may be required to keep the junction temperature below absolute maximum when the output is shorted indefinitely.

**Note 4:** Input offset voltage is pulse tested and is exclusive of warm-up drift.

**Note 5:** Slew rate is measured between ±2V on the output with ±3V input for ±5V supplies and 2V<sub>P-P</sub> on the output with a 3V<sub>P-P</sub> input for single 5V supplies.

**Note 6:** Full power bandwidth is calculated from the slew rate:  
FPBW = SR/2πV<sub>P</sub>.

**Note 7:** This parameter is not 100% tested.

**Note 8:** The LT1812C is guaranteed to meet specified performance from 0°C to 70°C. The LT1812C is designed, characterized and expected to meet specified performance from –40°C to 85°C but is not tested or QA sampled at these temperatures. The LT1812I is guaranteed to meet specified performance from –40°C to 85°C.

**Note 9:** Thermal resistance varies with the amount of PC board metal connected to the package. The nominal values are for short traces connected to the pins. The thermal resistance can be substantially reduced by connecting Pin 2 of the 5-lead or 6-lead SOT-23 or Pin 4 of the SO-8 to a large metal area.

**Note 10:** For the 8-lead SO and 6-lead SOT-23 parts, the electrical characteristics apply to the “ON” state, unless otherwise noted. These parts are in the “ON” state when either SHDN is not connected, or SHDN > V<sup>-</sup> + 2.0V.

**Note 11:** The shutdown (SHDN) feature is not available on the 5-lead SOT-23 parts. These parts are always in the “ON” state.

# TYPICAL PERFORMANCE CHARACTERISTICS

Supply Current vs Temperature

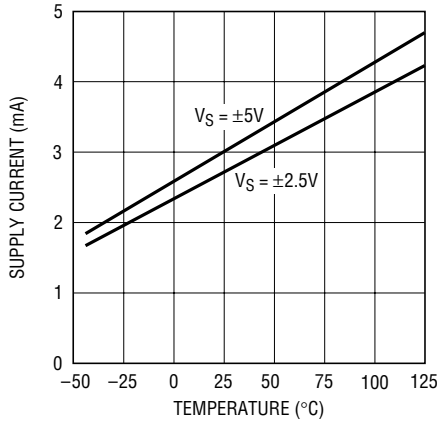

1812 G01

Input Common Mode Range vs Supply Voltage

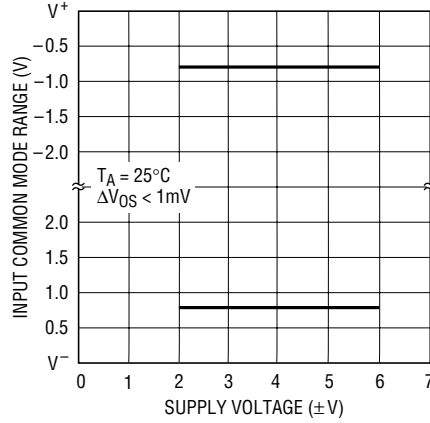

1812 G02

Input Bias Current vs Common Mode Voltage

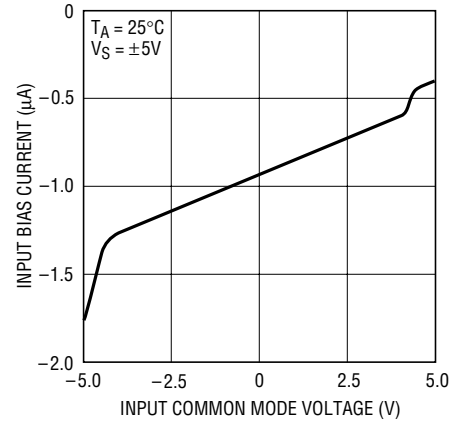

1812 G03

Input Bias Current vs Temperature

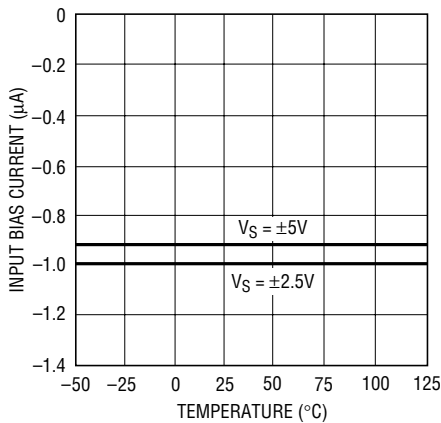

1812 G04

Input Noise Spectral Density

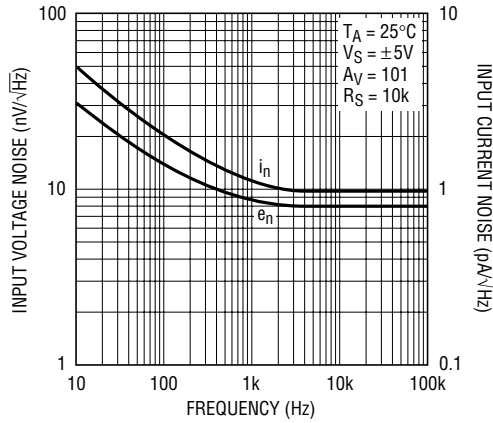

1812 G05

Open-Loop Gain vs Resistive Load

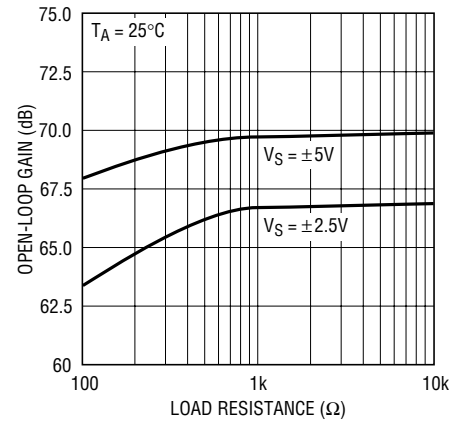

1812 G06

Open-Loop Gain vs Temperature

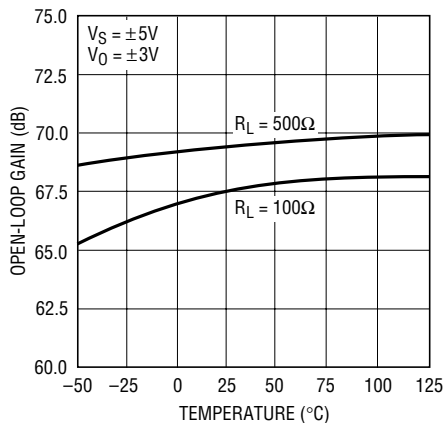

1812 G07

Output Voltage Swing vs Supply Voltage

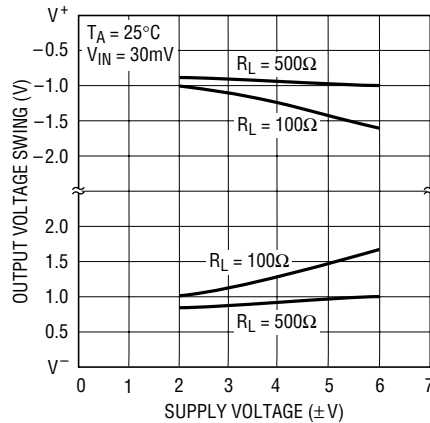

1812 G08

Output Voltage Swing vs Load Current

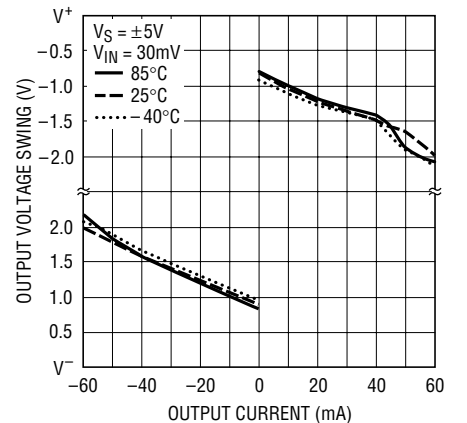

1812 G09

# TYPICAL PERFORMANCE CHARACTERISTICS

**Output Short-Circuit Current vs Temperature**

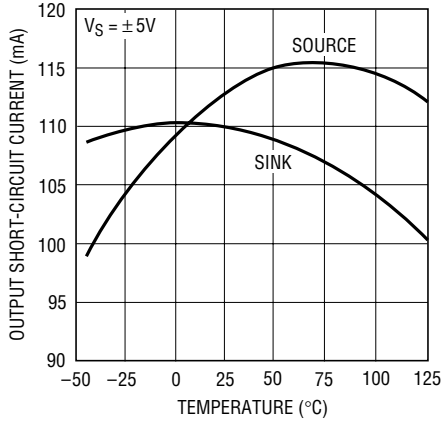

1812 G10

**Open-Loop Gain and Phase vs Frequency**

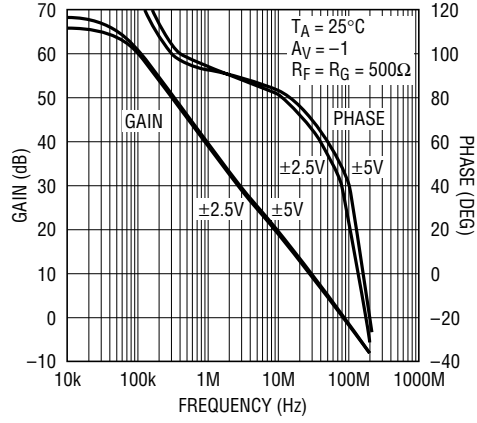

1812 G13

**Gain vs Frequency**

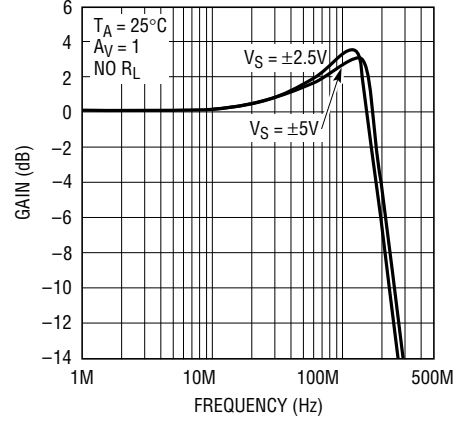

1812 G16

**Settling Time vs Output Step**

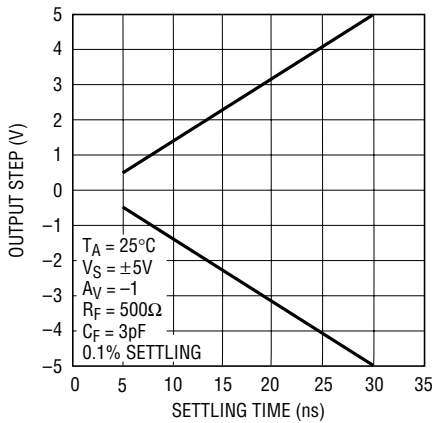

1812 G11

**Gain Bandwidth and Phase Margin vs Supply Voltage**

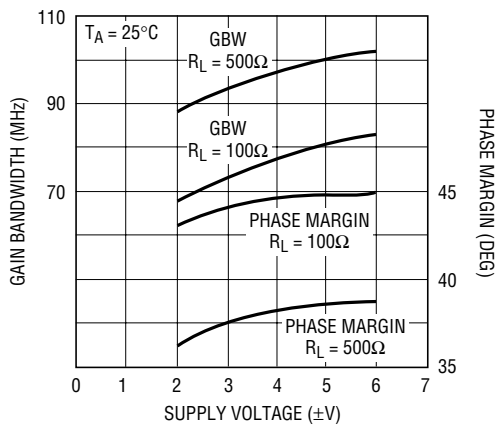

1812 G19

**Gain vs Frequency**

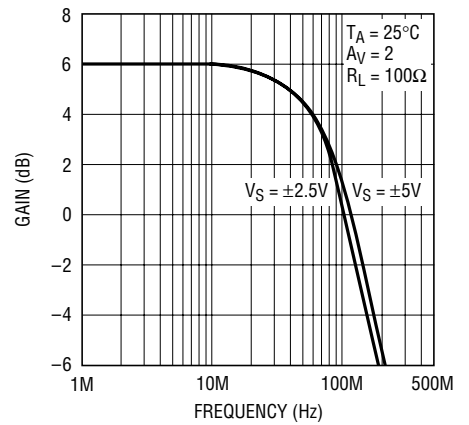

1812 G17

**Output Impedance vs Frequency**

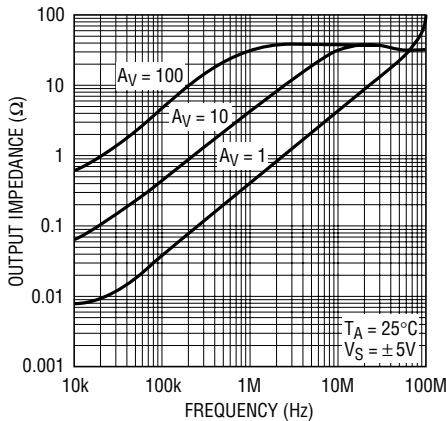

1812 G12

**Gain Bandwidth and Phase Margin vs Temperature**

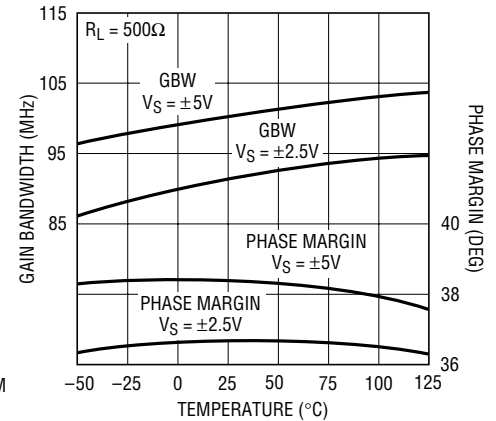

1812 G15

**Gain vs Frequency**

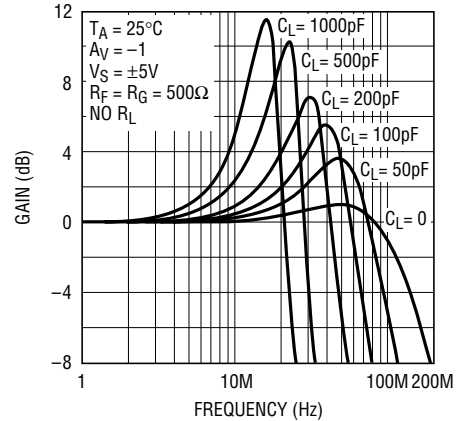

1812 G18



# TYPICAL PERFORMANCE CHARACTERISTICS

**Shutdown Supply Current vs Temperature**

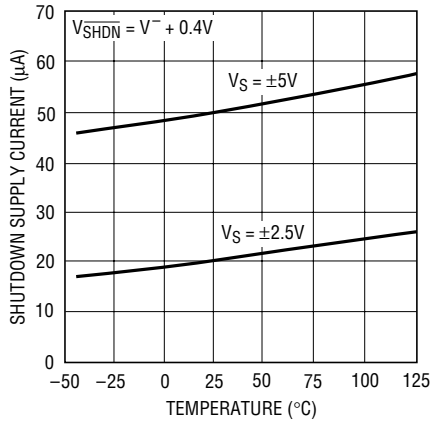

1812 G14

**Power Supply Rejection Ratio vs Frequency**

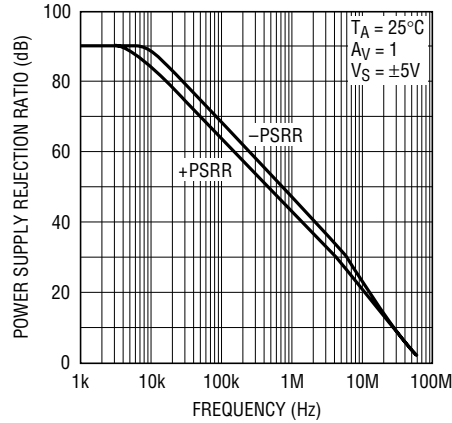

1812 G20

**Common Mode Rejection Ratio vs Frequency**

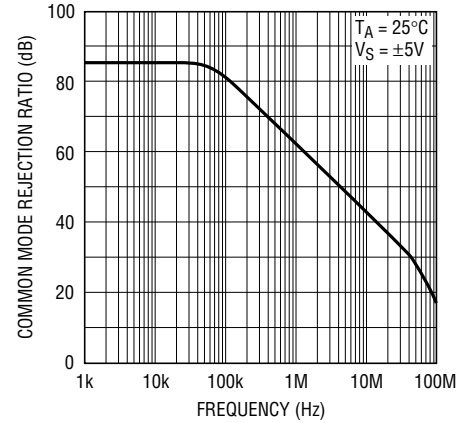

1812 G21

**Slew Rate vs Supply Voltage**

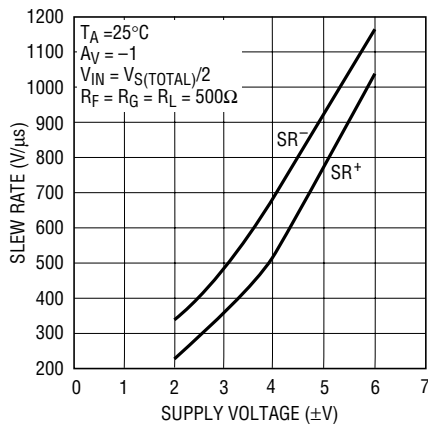

1812 G22

**Slew Rate vs Supply Voltage**

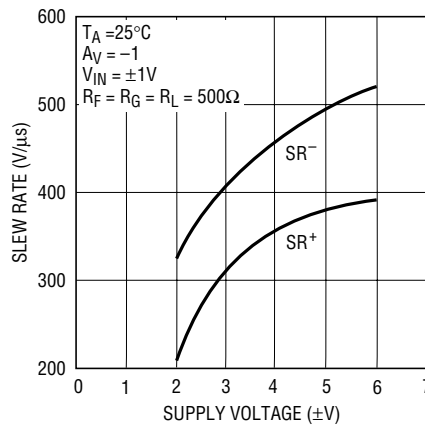

1812 G23

**Slew Rate vs Input Level**

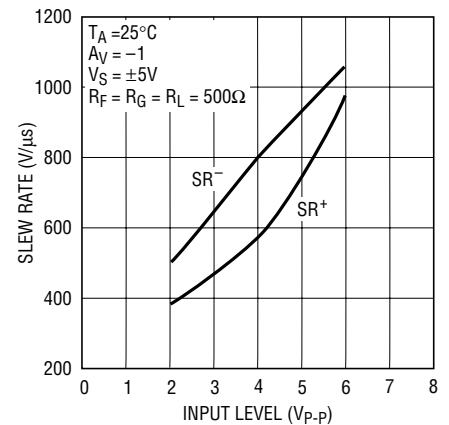

1812 G24

**Slew Rate vs Temperature**

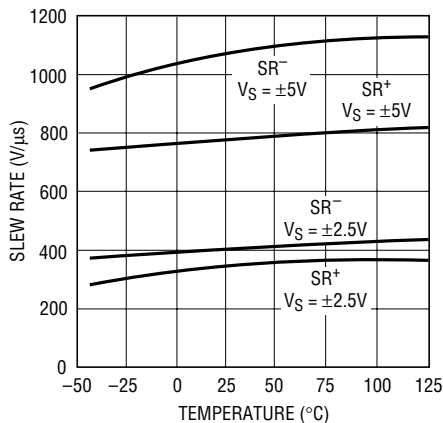

1812 G25

**Total Harmonic Distortion + Noise vs Frequency**

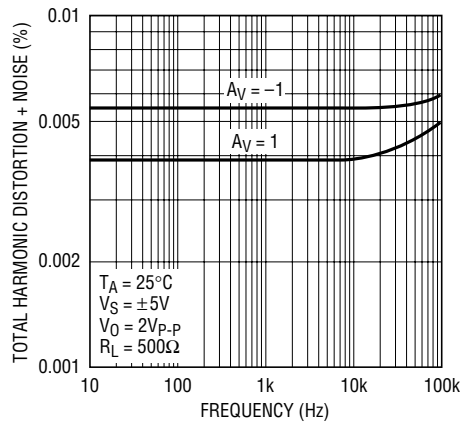

1812 G26

**Undistorted Output Swing vs Frequency**

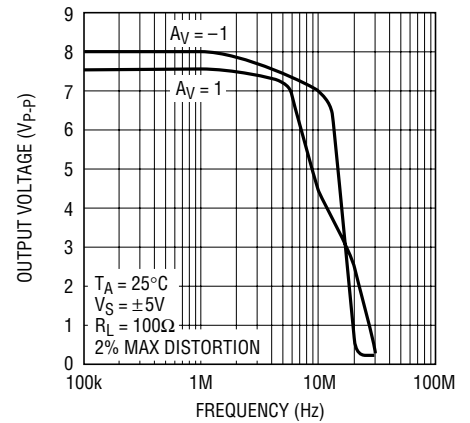

1812 G27

# TYPICAL PERFORMANCE CHARACTERISTICS

**2nd and 3rd Harmonic Distortion vs Frequency**

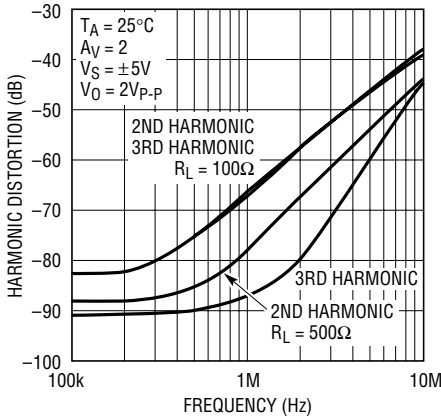

1812 G28

**Differential Gain and Phase vs Supply Voltage**

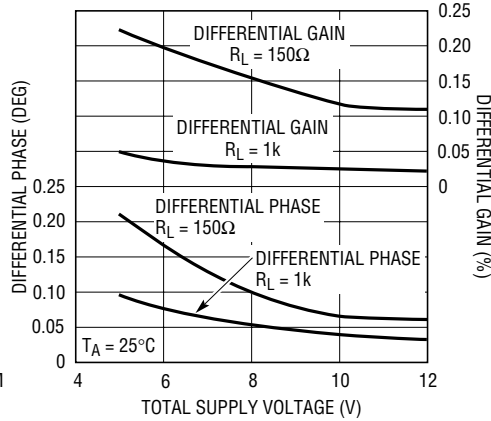

1812 G29

**Capacitive Load Handling**

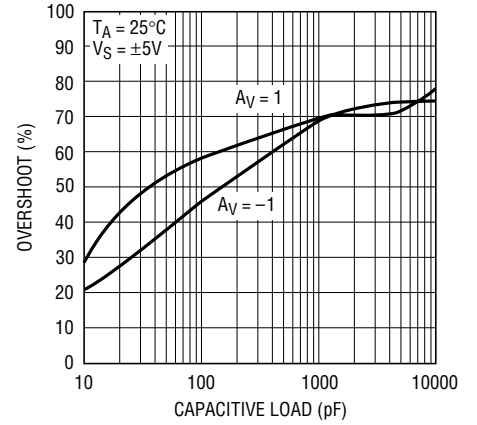

1812 G30

**Small-Signal Transient,  $A_V = -1$**

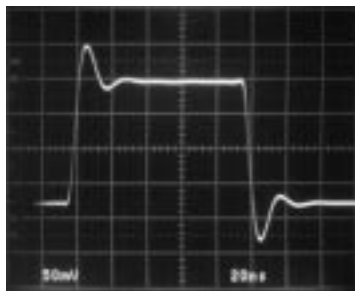

1812 G31

**Small-Signal Transient,  $A_V = 1$**

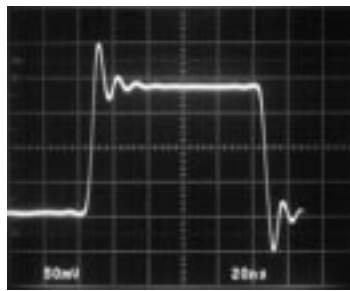

1812 G32

**Small-Signal Transient,  $A_V = 1, C_L = 1000\text{pF}$**

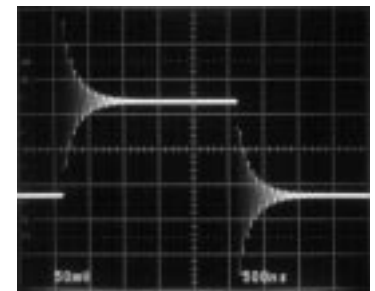

1812 G33

**Large-Signal Transient,  $A_V = -1$**

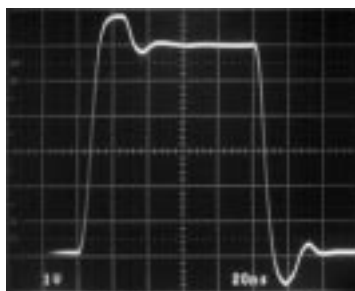

1812 G34

**Large-Signal Transient,  $A_V = 1$**

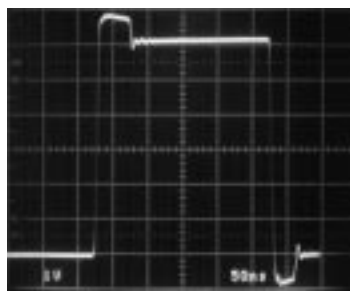

1812 G35

**Large-Signal Transient,  $A_V = 1, C_L = 1000\text{pF}$**

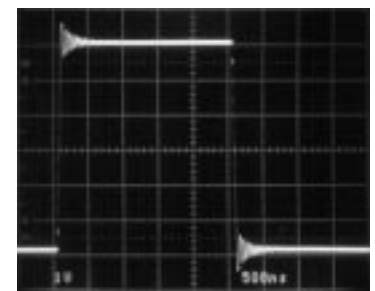

1812 G36

## APPLICATIONS INFORMATION

### Layout and Passive Components

The LT1812 amplifier is more tolerant of less than ideal layouts than other high speed amplifiers. For maximum performance (for example, fast settling) use a ground plane, short lead lengths and RF-quality bypass capacitors (0.01 $\mu$ F to 0.1 $\mu$ F). For high drive current applications, use low ESR bypass capacitors (1 $\mu$ F to 10 $\mu$ F tantalum).

The parallel combination of the feedback resistor and gain setting resistor on the inverting input combine with the input capacitance to form a pole that can cause peaking or even oscillations. If feedback resistors greater than 2k are used, a parallel capacitor of value

$$C_F > R_G \cdot C_{IN}/R_F$$

should be used to cancel the input pole and optimize dynamic performance. For applications where the DC noise gain is 1 and a large feedback resistor is used,  $C_F$  should be greater than or equal to  $C_{IN}$ . An example would be an I-to-V converter.

### Input Considerations

Each of the LT1812 amplifier inputs is the base of an NPN and PNP transistor whose base currents are of opposite polarity and provide first-order bias current cancellation. Because of variation in the matching of NPN and PNP beta, the polarity of the input bias current can be positive or negative. The offset current does not depend on beta matching and is well controlled. The use of balanced source resistance at each input is recommended for applications where DC accuracy must be maximized. The inputs can withstand differential input voltages of up to 3V without damage and need no clamping or source resistance for protection.

**The device should not be used as a comparator** because with sustained differential inputs, excessive power dissipation may result.

### Capacitive Loading

The LT1812 is stable with a 1000pF capacitive load, which is outstanding for a 100MHz amplifier. This is accomplished by sensing the load induced output pole and adding compensation at the amplifier gain node. As the

capacitive load increases, both the bandwidth and phase margin decrease so there will be peaking in the frequency domain and in the transient response. Coaxial cable can be driven directly, but for best pulse fidelity, a resistor of value equal to the characteristic impedance of the cable (i.e., 75 $\Omega$ ) should be placed in series with the output. The other end of the cable should be terminated with the same value resistor to ground.

### Slew Rate

The slew rate is proportional to the differential input voltage. Highest slew rates are therefore seen in the lowest gain configurations. For example, a 5V output step in a gain of 10 has a 0.5V input step, whereas in unity gain there is a 5V input step. The LT1812 is tested for slew rate in a gain of  $-1$ . Lower slew rates occur in higher gain configurations.

### Shutdown

The LT1812 has a shutdown pin ( $\overline{\text{SHDN}}$ , Pin 8) for conserving power. When this pin is open or biased at least 2V above the negative supply, the part operates normally. When pulled down to  $V^-$ , the supply current drops to about 50 $\mu$ A. Typically, the turn-off delay is 1 $\mu$ s and the turn-on delay 0.5 $\mu$ s. The current out of the  $\overline{\text{SHDN}}$  pin is also typically 50 $\mu$ A. In shutdown mode, the amplifier output is not isolated from the inputs, so the LT1812 shutdown feature cannot be used for multiplexing applications. The 50 $\mu$ A typical shutdown current is exclusive of any output (load) current. In order to prevent load current (and maximize the power savings), either the load needs to be disconnected, or the input signal needs to be 0V. Even in shutdown mode, the LT1812 can still drive significant current into a load. For example, in an  $A_V = 1$  configuration, when driven with a 1V DC input, the LT1812 drives 2mA into a 100 $\Omega$  load. It takes about 500 $\mu$ s for the load current to reach this value.

### Power Dissipation

The LT1812 combines high speed and large output drive in a small package. It is possible to exceed the maximum junction temperature under certain conditions. Maximum

## APPLICATIONS INFORMATION

junction temperature ( $T_J$ ) is calculated from the ambient temperature ( $T_A$ ) and power dissipation ( $P_D$ ) as follows:

$$T_J = T_A + (P_D \cdot \theta_{JA}) \text{ (Note 9)}$$

Power dissipation is composed of two parts. The first is due to the quiescent supply current and the second is due to on-chip dissipation caused by the load current. The worst-case load induced power occurs when the output voltage is at 1/2 of either supply voltage (or the maximum swing if less than 1/2 supply voltage). Therefore  $P_{D\text{MAX}}$  is:

$$P_{D\text{MAX}} = (V^+ - V^-)(I_{S\text{MAX}}) + (V^+/2)^2/R_L \text{ or}$$

$$P_{D\text{MAX}} = (V^+ - V^-)(I_{S\text{MAX}}) + (V^+ - V_{O\text{MAX}})(V_{O\text{MAX}}/R_L)$$

Example: LT1812CS5 at 70°C,  $V_S = \pm 5V$ ,  $R_L = 100\Omega$

$$P_{D\text{MAX}} = (10V)(4.5mA) + (2.5V)^2/100\Omega = 108mW$$

$$T_{J\text{MAX}} = 70^\circ\text{C} + (108mW)(250^\circ\text{C/W}) = 97^\circ\text{C}$$

### Circuit Operation

The LT1812 circuit topology is a true voltage feedback amplifier that has the slewing behavior of a current feedback amplifier. The operation of the circuit can be understood by referring to the Simplified Schematic. The inputs are buffered by complementary NPN and PNP emitter followers that drive a 300Ω resistor. The input voltage

appears across the resistor generating currents that are mirrored into the high impedance node. Complementary followers form an output stage that buffers the gain node from the load. The bandwidth is set by the input resistor and the capacitance on the high impedance node. The slew rate is determined by the current available to charge the gain node capacitance. This current is the differential input voltage divided by R1, so the slew rate is proportional to the input. Highest slew rates are therefore seen in the lowest gain configurations. The RC network across the output stage is bootstrapped when the amplifier is driving a light or moderate load and has no effect under normal operation. When driving capacitive loads (or a low value resistive load) the network is incompletely bootstrapped and adds to the compensation at the high impedance node. The added capacitance slows down the amplifier which improves the phase margin by moving the unity-gain cross away from the pole formed by the output impedance and the capacitive load. The zero created by the RC combination adds phase to ensure that the total phase lag does not exceed 180 degrees (zero phase margin) and the amplifier remains stable. In this way, the LT1812 is stable with up to 1000pF capacitive loads in unity gain, and even higher capacitive loads in higher closed-loop gain configurations.

## SIMPLIFIED SCHEMATIC

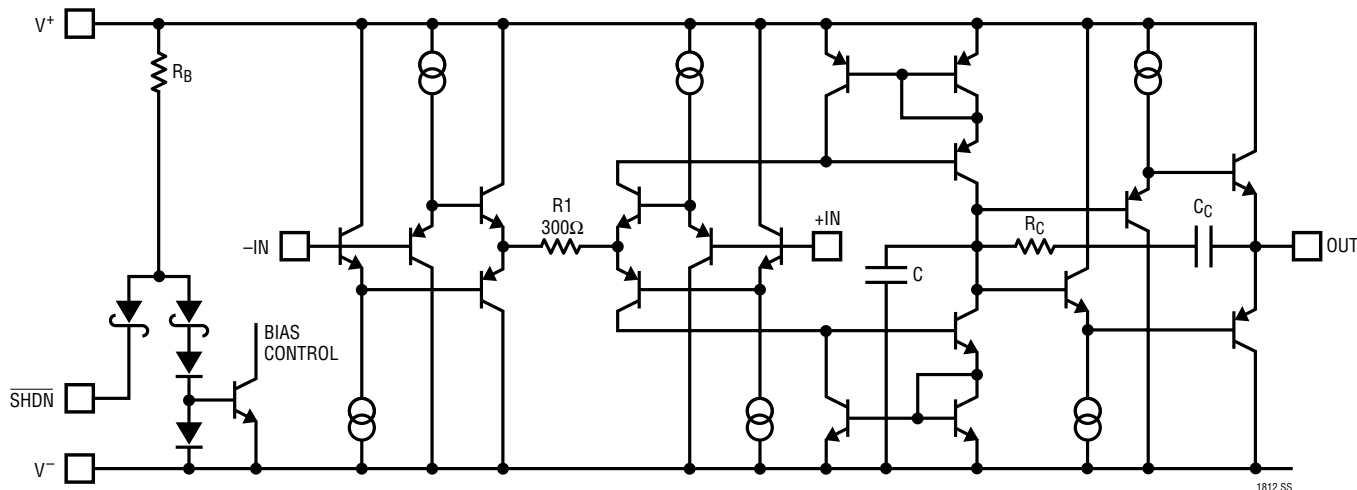

**PACKAGE DESCRIPTION** Dimensions in inches (millimeters) unless otherwise noted.

**S5 Package**  
**5-Lead Plastic SOT-23**  
 (LTC DWG # 05-08-1633)

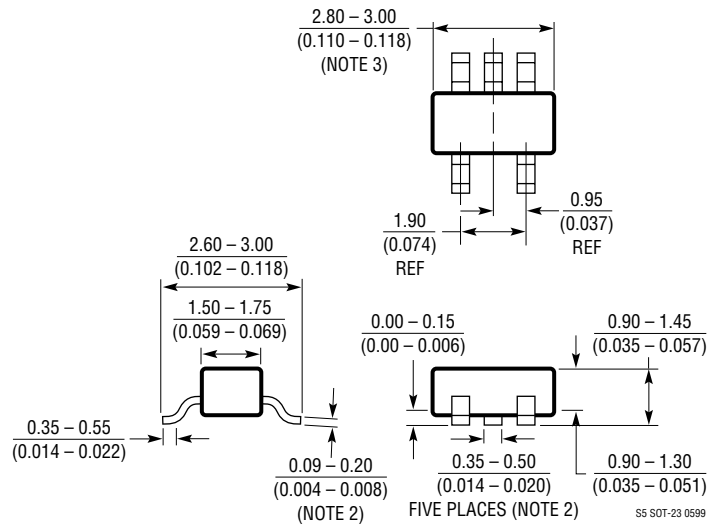

- NOTE:
1. DIMENSIONS ARE IN MILLIMETERS
  2. DIMENSIONS ARE INCLUSIVE OF PLATING
  3. DIMENSIONS ARE EXCLUSIVE OF MOLD FLASH AND METAL BURR
  4. MOLD FLASH SHALL NOT EXCEED 0.254mm
  5. PACKAGE EIAJ REFERENCE IS SC-74A (EIAJ)

**PACKAGE DESCRIPTION** Dimensions in inches (millimeters) unless otherwise noted.

**S6 Package**  
**6-Lead Plastic SOT-23**  
 (LTC DWG # 05-08-1634)

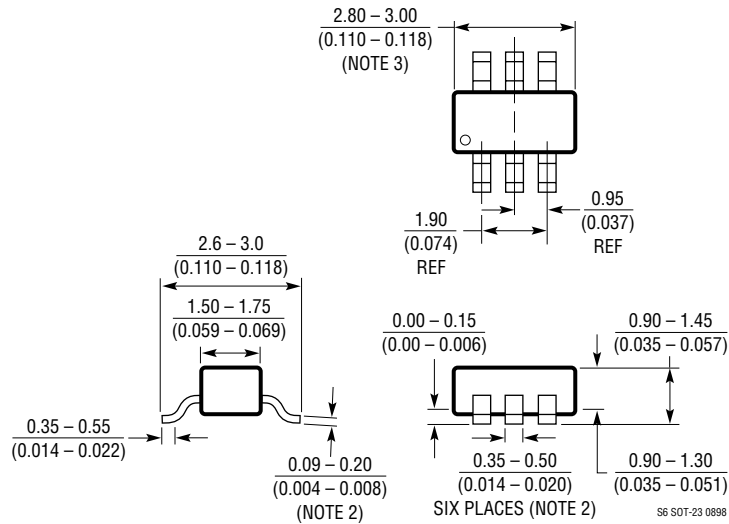

- NOTE:
1. DIMENSIONS ARE IN MILLIMETERS
  2. DIMENSIONS ARE INCLUSIVE OF PLATING
  3. DIMENSIONS ARE EXCLUSIVE OF MOLD FLASH AND METAL BURR
  4. MOLD FLASH SHALL NOT EXCEED 0.254mm
  5. PACKAGE EIAJ REFERENCE IS SC-74A (EIAJ)

**PACKAGE DESCRIPTION** Dimensions in inches (millimeters) unless otherwise noted.

**S8 Package**  
**8-Lead Plastic Small Outline (Narrow 0.150)**  
 (LTC DWG # 05-08-1610)

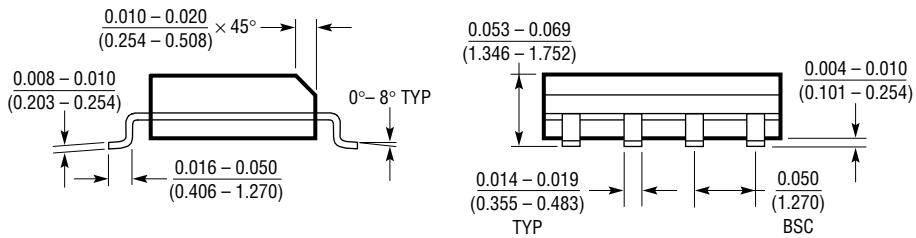
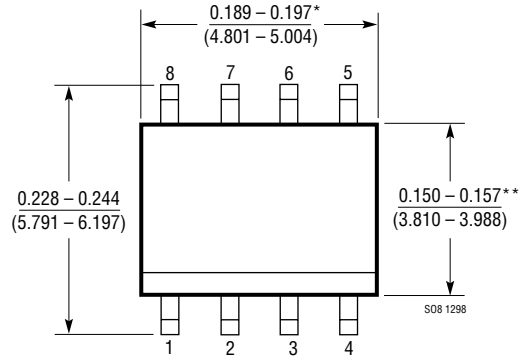

- \*DIMENSION DOES NOT INCLUDE MOLD FLASH. MOLD FLASH SHALL NOT EXCEED 0.006" (0.152mm) PER SIDE
- \*\*DIMENSION DOES NOT INCLUDE INTERLEAD FLASH. INTERLEAD FLASH SHALL NOT EXCEED 0.010" (0.254mm) PER SIDE

## TYPICAL APPLICATION

Single 5V Supply 10MS/s 12-Bit ADC Buffer

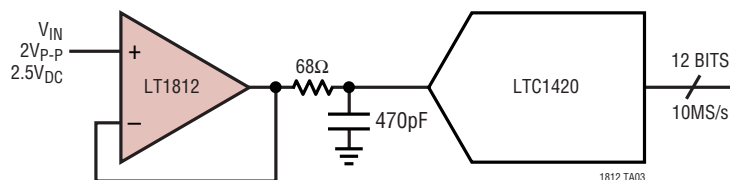

## RELATED PARTS

PART NUMBER	DESCRIPTION	COMMENTS
LT1360/LT1361/LT1362	Single/Dual/Quad 50MHz, 800V/μs, C-Load™ Amplifiers	4mA Supply Current, 1mV Max V <sub>OS</sub> , 1μA Max I <sub>B</sub>
LT1363/LT1364/LT1365	Single/Dual/Quad 70MHz, 1000V/μs C-Load Amplifiers	50mA Output Current, 1.5mV Max V <sub>OS</sub> , 2μA Max I <sub>B</sub>
LT1395/LT1396/LT1397	Single/Dual/Quad 400MHz Current Feedback Amplifiers	4.6mA Supply Current, 800V/μs, 80mA Output Current
LT1806	325MHz, 140V/μs Rail-to-Rail I/O Op Amp	Low Noise 3.5nV/√Hz
LT1809	180MHz, 350V/μs Rail-to-Rail I/O Op Amp	Low Distortion -90dBc at 5MHz
LT1813	Dual 3mA, 100MHz, 750V/μs Operational Amplifier	Dual Version of the LT1812

C-Load is a trademark of Linear Technology Corporation.